



DIG SILENT

# PowerFactory 2019

INTEGRATED POWER SYSTEM ANALYSIS SOFTWARE FOR  
TRANSMISSION / DISTRIBUTION / INDUSTRY / GENERATION / INTEGRATION OF RENEWABLES

# DlgSILENT | PowerFactory 2019

## Product Application

DlgSILENT has set standards and trends in power system modelling, analysis and simulation for more than 25 years. The proven advantages of PowerFactory software are its overall functional integration, its applicability to the modelling of generation, transmission, distribution and industrial grids and the analysis of their interactions. With its rich modelling capabilities, PowerFactory is perfectly suited for network planning and operation studies of increasingly smart grids.



### POWER TRANSMISSION

Transmission grids are currently undergoing major changes to reliably accommodate increasing amounts of nondispatchable resources while maintaining operational efficiency and minimising system-wide cost. The displacement of less flexible base-load generation by asynchronous wind and solar power generators imposes new challenges on the ability of the grid to maintain system stability.

PowerFactory offers a complete suite of functions for studying large interconnected power systems and addressing these emerging needs. Its fast and robust simulation algorithms can be applied to any AC or DC network topology and support the simulation of new technologies such as converter-based power generation, FACTS, voltage-sourced converters (VSC), HVDC cables and overhead lines, DC breakers, filters, and various types of MW- and Mvar-controllers and virtual power plants.

PowerFactory is also perfectly suited to transmission system

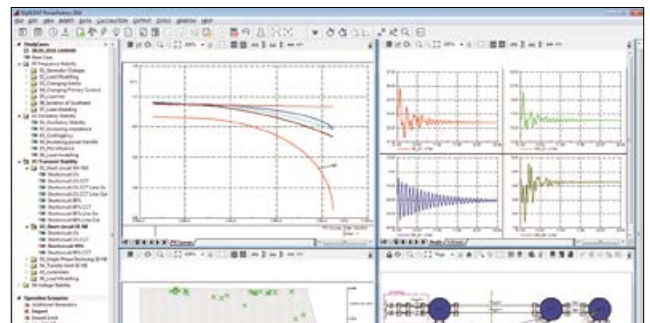

operation planning. It integrates a comprehensive set of tools to support automatic and parallel grid safety analysis such as ENTSO-E D2CF/DACF/IDCF, and outage planning. Multiple interfaces (API, DGS, CIM) and flexible scripting languages (DPL, Python) enable smooth integration with existing systems. With its Unit Commitment and Dispatch Optimisation module PowerFactory offers essential tools for Market Simulation studies including all grid and network security constraints.



### POWER DISTRIBUTION

New challenges like reverse power flow and voltage rise through distributed generation, as well as the integration of E-mobility, give rise to increased complexity in planning and operating distribution networks. This leads to a greater need for network optimisation together with higher complexity.

To handle these challenges, PowerFactory offers suitable powerful tools and functions. Using inbuilt interfaces, the creation of the network and the input of measurement values can be achieved by utilising available GIS and SCADA data. Based on these data, the current state of the network can be assessed; for example the load and generation hosting capacity can be evaluated. For further proactive optimisation of the network, there are numerous functions available, such as Tie Open Point Optimisation, Voltage Profile Optimisation and Phase Balance Optimisation.

With the easy-to-use Quasi-Dynamic Simulation, the various effects and interactions of volatile distributed generation with new network infrastructure, such as Battery storage systems with user defined controls, as well as conventional equipment can be analysed in time-sweep studies.

### OTHER IMPORTANT ASPECTS:

- Probabilistic analysis with stochastic modelling of distributed generation and load consumption
- Reliability Analysis including Optimal Power Restoration schedules
- Interactive geographic diagrams (GPS-based) with flexible layer concept and background maps
- Power Quality and Harmonic Analysis
- Protection functions



## INDUSTRIAL SYSTEMS

To ensure continuity of production and the safety of personnel, the proper operation of industrial networks is of utmost importance. With high precision load flow algorithms, flexible short-circuit calculation features, 4-wire modelling, protection system modelling, harmonic analysis and filter design options, PowerFactory offers a vast array of functionality perfectly suited to the industrial user's needs. In addition, PowerFactory provides calculation accuracy, appropriate standards, clearly presented results, and a comprehensive and user-friendly interface.

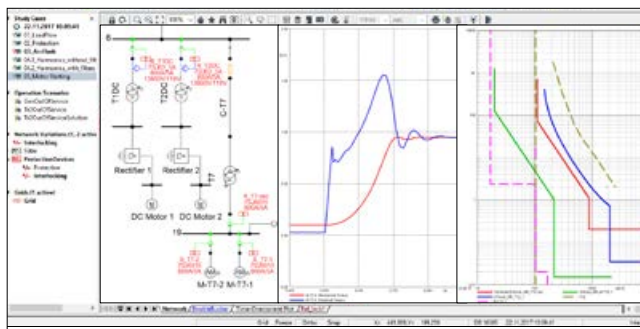

### TYPICALLY REQUIRED STUDIES INCLUDE:

Analysis of voltage drop and transformer and generator regulation using load flow functionality

Short-circuit calculations according to IEC, ANSI and VDE standards

HV & LV cable sizing according to IEC, NF and BS standards; ampacity, voltage drop, short-circuit capability

Motor starting, re-acceleration and voltage drop analysis

Protection scheme coordination (overcurrent, differential, distance and signalling)

Harmonic distortion and resonance studies; filter sizing

Network reliability analysis, scenarios and fault models

Time domain simulation for stability analysis and examination of electromagnetic transients



## POWER GENERATION

Power plants represent the core of any power system. Their efficiency, reliability and stability are essential. PowerFactory offers the tools for analysing all aspects of their electric components.



### POWERFACTORY CAPABILITIES:

Models of generators, governors (steam, gas, diesel, hydro), automatic voltage regulators (AVRs) and power system stabilisers (PSSs)

Voltage dependent PQ capability curves

Models of motors, protection relays, power electronic converters and DC equipment

Calculation of short-circuit currents

- in AC grids according to IEC 60909 (VDE 0102, incl. 2016 edition) and ANSI
- in DC auxiliary supply grids according to IEC 61660 and ANSI/IEEE 946

Unit Commitment and Dispatch Optimisation including grid and security constraints

Stability and EMT simulation

- Behaviour during short-circuits and load changes
- Frequency control
- Transient stability
- Sub-synchronous resonances
- Transformer inrush

Model frequency response analysis (Bode and Nyquist Diagrams)

Interface for real-time measurement data from DiGSILENT monitoring system PFM for online grid code compliance supervision or model validation

# DIgSILENT | PowerFactory 2019

## Power System Analysis Software



### DISTRIBUTED GENERATION

Power system phenomena such as reverse power flows, voltage dips and swells, varying fault levels and equipment loading are some of the challenges arising from distributed generation in electricity systems. Of particular note are the challenges of forecasting renewable energy generation with respect to the transfer capacity of distribution feeders under increasing deployment of smart grid technologies such as smart meters, demand side management and storage options.

PowerFactory is perfectly suited for the analysis of these challenges. It combines classical distribution system study functions such as voltage drop/rise calculation, unbalanced network assessment, short-circuit current calculation (including IEC 60909:2016) and protection selectivity analysis with modern analysis tools featuring quasi-dynamic simulations, voltage plan optimisation, hosting capacity analysis, stochastic assessment with probabilistic load flow or reliability analysis, and power quality assessment.

The comprehensive model library in PowerFactory provides users with the ability to use ready-made objects for single and three-phase loads, consumption energy profiles, generators and converters, PV installations featuring integrated power calculation based on solar radiation, fuel cells, wind generators, micro-turbines and battery storage, etc. as well as dynamic models (e.g. WECC DER\_A).



### RENEWABLES

Complex studies for the integration of renewable generation into electrical networks are now a key requirement in network planning and analysis. PowerFactory combines extensive modelling capabilities with advanced solution algorithms, thereby providing the analyst with tools to undertake the full range of studies required for grid connection and grid impact analysis of wind parks, PV plants and all other kind of power park modules using renewable energies:

Steady-state load flow calculations considering voltage-dependent reactive power capability limits, power park controllers with setpoint characteristics, etc.

Short-circuit calculation acc. to IEC 60909 (incl. 2016 edition) and ANSI, and complete method with dynamic voltage support acc. to k-factor settings

Stochastic wind models and probabilistic analysis tools

Balanced and unbalanced stability and EMT analysis

Multiple domain co-simulation (RMS/EMT)

Models for all established generator/converter types, controlled shunts and STATCOMs

Dynamic models acc. to IEC 61400-27-1 and WECC

Power quality assessment according to IEC 61400-21, plus capability to consider frequency-dependent Norton equivalents

HVDC link models for offshore wind park connections

Model frequency response analysis (Bode and Nyquist Diagrams)

Interface for real-time measurement data from DIgSILENT monitoring system PFM for online grid code compliance supervision or model validation

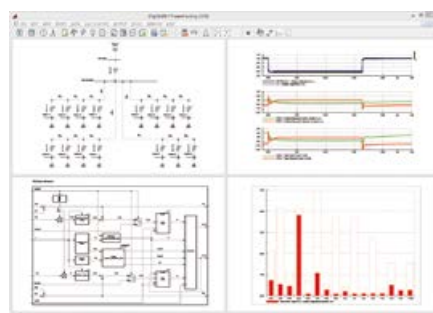



# DIGSILENT | PowerFactory 2019

## System Integration

### GIS INTEGRATION

Geographic Information Systems (GIS) together with Asset Management Systems are the main sources of network topology and equipment data. Many utilities use GIS exports as a basis for the PowerFactory network model. These exports may comprise detailed substation data including topology, line/cable data, load/generation data and GPS coordinates/schematic diagram information, etc.

The built-in Compare & Merge Tool and the versioning mechanism perfectly support the frequent data exchange with GIS.

Alternatively, PowerFactory Engines can directly be integrated into GIS systems providing calculation functionality such as evaluation of renewable generation connected to the low voltage grid.

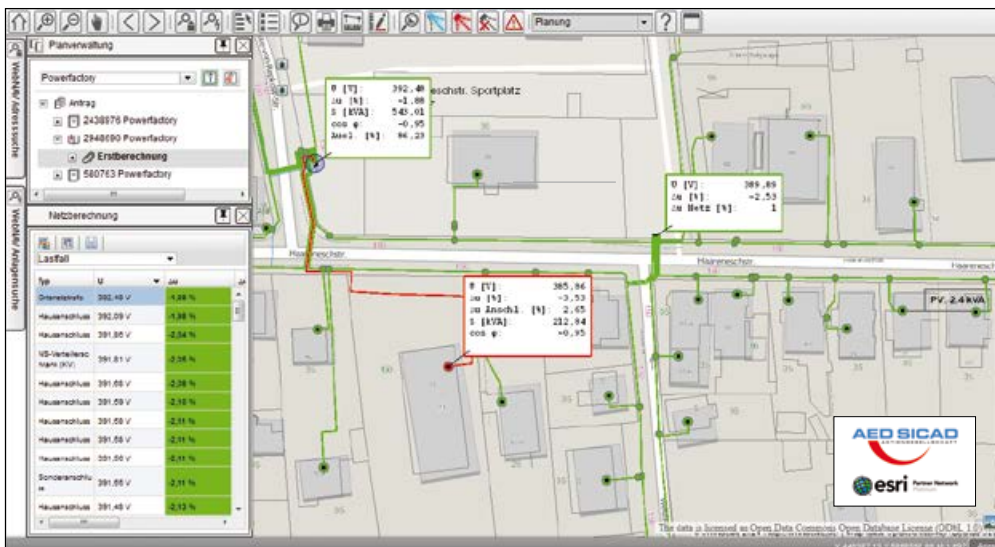

### SCADA INTEGRATION

The PowerFactory OPC interface is utilised worldwide for real-time integration of PowerFactory with SCADA systems. The applications range from Online State Estimation, simulation mode functions (Dispatcher Load Flow, Contingency Analysis, Switching Validation) to Dispatcher Training Simulator with real-time transient grid simulation.

Controller manufacturers use the PowerFactory OPC interface for controller development, e.g. smart grid controllers, PV or wind farm control schemes.



# DIgSILENT | PowerFactory 2019

## System Integration

### BUSINESS PROCESS AUTOMATION

PowerFactory supports standard ENTSO-E operation planning processes such as D2CF, DACF and IDCF (Intraday). The Intraday process runs as a fully-automated, parallelised process. In addition, PowerFactory is compliant with the ENTSO-E CGMES data exchange standard.

The ESB interface adapter features message-based data exchange such as load forecast, planned generator dispatch, day-ahead

cross-border exchange programs, UCTE-DEF files, EMS snapshots, dynamic line rating and market coupling data.

The combined MV/LV calculation for the distribution grid of a whole country (>2000 MV substations) has been automated using PowerFactory and bulk data GIS exports.

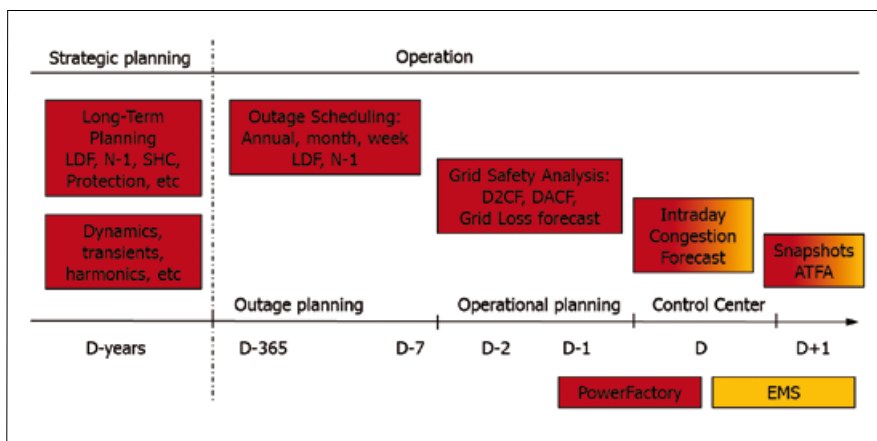

### INTEGRATION COMPONENTS

PowerFactory operated in automation mode provides complete PowerFactory functionality for external systems. The Engines can be controlled via the PowerFactory API and DPL or Python scripts. Various interfaces such as CIM, UCTE-DEF, OPC and DGS support bi-directional data exchange with different systems.

The ESB interface adapter connects to an Enterprise Service Bus enabling modern message-based data exchange.

The Engine Manager component provides access to multiple PowerFactory Engines via web services. The built-in queuing and scheduling simplifies the Engine integration into other applications.

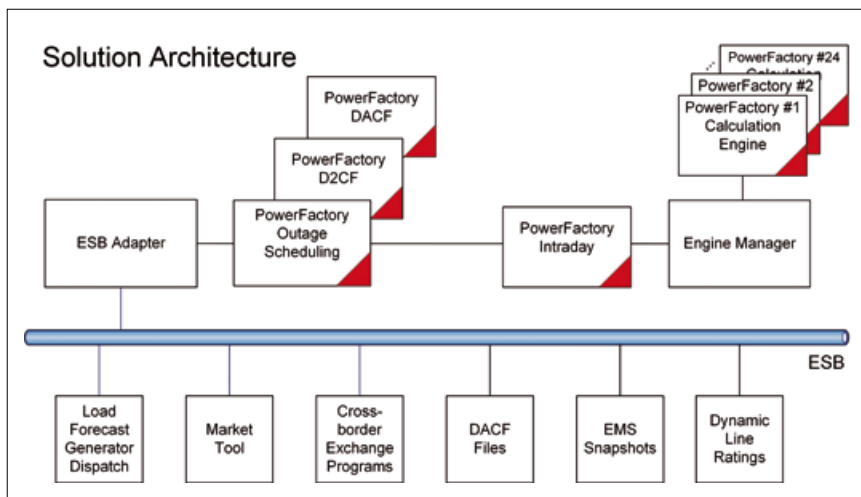

# DlgSILENT | PowerFactory

## Highlights

PowerFactory is a leading power system analysis software application for use in analysing generation, transmission, distribution and industrial systems. It covers the full range of functionality from standard features to highly sophisticated and advanced applications including windpower, distributed generation, real-time simulation and performance monitoring for system testing and supervision.

PowerFactory is easy to use, fully Windows compatible and combines reliable and flexible system modelling capabilities with state-of-the-art algorithms and a unique database concept. Also, with its flexibility for scripting and interfacing, PowerFactory is perfectly suited to highly automated and integrated solutions in your business applications.

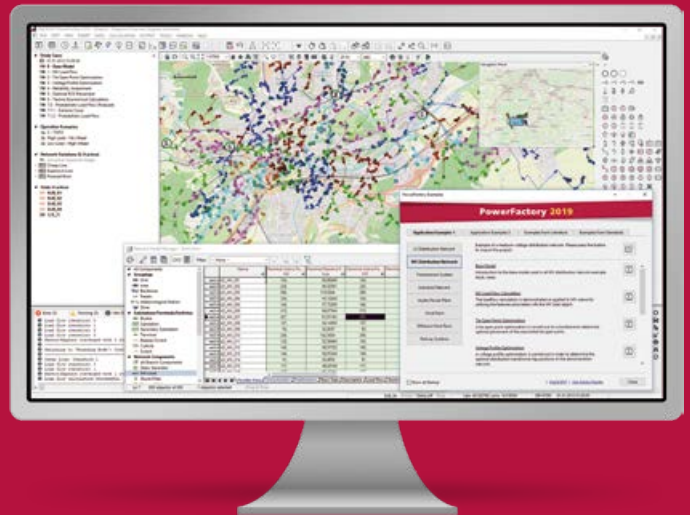

### SOME HIGHLIGHTS:

Economical all-in-one solution with broad coverage of state-of-the-art power system applications

Extensive and flexible modelling capabilities with rich suite of power equipment models and libraries

Supports all network representations and phase technologies, i.e. any kind of radial or meshed 1-,2-,3- and 4-wire (combined) AC and DC networks

Powerful network diagram and graphic/visualisation features

Single- and multi-user environment with full support of team-working, user accounting, profiles and flexible customisation

Unique data management concept including project versioning and archiving mechanisms, master/derived concepts with compare and merge tools

Unlimited opportunities in process optimisation based on integrated scripting functionality

Rich interfacing and system integration options (e.g. GIS, SCADA, EMS)

Professional support via customer portal or hotline, as well as continuous product maintenance and development

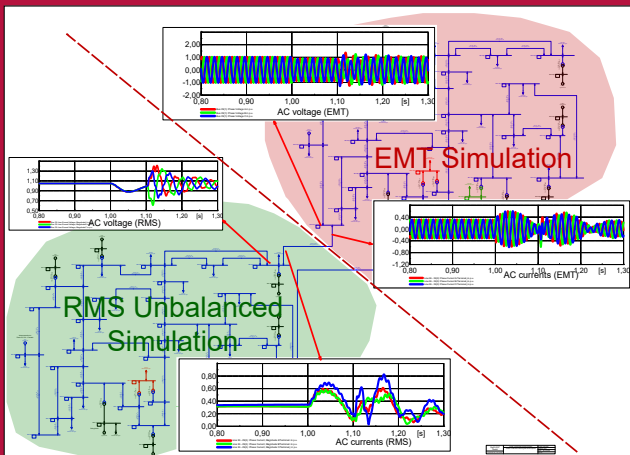

### Software Editions

#### PowerFactory Single-User Edition

- Single-user licence with local database
- Local licence

#### PowerFactory Team Edition

- Multi-user licence for multi-user database with Microsoft SQL Server and/or Oracle Database
- Network licence with optional floating licence

#### PowerFactory Multi-User Edition

- Multi-user licence with local databases
- Network licence with optional floating licence

#### PowerFactory Engine Edition

- GUI-less application for integrated/automated solutions
- Local licence or network licence

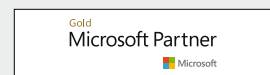

#### Minimum System Requirements

- Display with minimum 1280x1024 resolution
- Intel/AMD CPU; 2 GHz or faster
- 2 GB available hard disk plus additional 5 GB per user
- Minimum 2 GB RAM available for PowerFactory process depending on network size and type of calculations
- Licence requires regular online access (every 30 days)

#### Supported Windows operating Systems:

Windows 7, Windows 8, Windows 10,  
Windows Server 2008, 2008 R2, 2012, 2012 R2, 2016

#### Multi-User Database

- Microsoft SQL 2008, 2012, 2014, 2016, 2017
- Oracle Server 10.2 or higher with Client 12.1 or 12.2



## Base Package

The PowerFactory Base Package provides analysis modules coupled with a wide range of power equipment models, integrated tools and features for fundamental power system applications.

### BASIC FUNCTIONS AND INTEGRATED FEATURES

---

Load Flow Analysis

---

Short-Circuit Analysis

---

Load Flow Sensitivities

---

Basic MV/LV Network Analysis

---

Power Equipment Models

---

Network Representation

---

Network Model Management

---

Network Diagrams and Graphic Features

---

Results and Reporting

---

Various Data Converters

## Advanced Functions

The Base Package can be extended using a wide range of additional functions according to specific user requirements. In addition, various interfaces are available to further customise the PowerFactory package.

---

Contingency Analysis

---

Quasi-Dynamic Simulation

---

Network Reduction

---

Protection Functions

---

Arc-Flash Analysis

---

Cable Analysis

---

Power Quality and Harmonic Analysis

---

Connection Request Assessment

---

Transmission Network Tools

---

Distribution Network Tools

---

Outage Planning

---

Probabilistic Analysis

---

Reliability Analysis Functions

---

Optimal Power Flow (OPF)

---

Unit Commitment and Dispatch Optimisation **NEW**

---

Techno-Economical Analysis

---

State Estimation

---

Stability Analysis Functions (RMS)

---

Electromagnetic Transients (EMT)

---

Motor Starting Functions

---

Small Signal Stability (Eigenvalue Analysis)

---

System Parameter Identification

---

Interfaces

---

Scripting and Automation

## Base Package

### LOAD FLOW ANALYSIS

- Balanced and unbalanced load flow for coupled AC and DC grids
- Meshed DC supergrid load flow analysis
- State-of-the-art numerical solvers for fast and robust convergence from arbitrary starting-points
- Active/reactive power and voltage regulation options, such as SVC, shunt and tap controllers
- Station- and network control features, including Q(U)-, cosphi(P)-, Q(P)-, and droop characteristics
- Local- and remote control options
- Secondary and primary control, inertial response
- Distributed slack by load and generation, including interchange schedules
- Consideration of active and reactive power limits, including (voltage-dependent) generator capability curves
- Accurate modelling of induction machines
- Voltage dependent load models
- User-definable load flow controller models
- Simple load/generation scaling, as well as automated feeder load scaling (balanced and unbalanced)
- Determination of "power at risk"
- Consideration of temperature dependency
- DPL scripts for ATC, penalty factor calculation, etc.

### SHORT-CIRCUIT ANALYSIS

- Support of IEC 60909 (including 2016 edition), IEEE 141/ANSI C37, VDE 0102/0103, G74 and IEC 61363 norms and methods
- Calculation of short-circuit currents in DC grids according to IEC 61660 and ANSI/IEEE 946
- Complete superposition method, including dynamic voltage support of generators connected via power electronics
- Fast multiple fault analysis of any kind of fault including single-phase interruption, inter-circuit faults, fault sweep along lines, customisable short-circuit sweep diagrams, etc.

### LOAD FLOW SENSITIVITIES

- Voltage sensitivities and branch flow sensitivities
- Transformer and booster sensitivities (continuous and discrete)
- Modal analysis for identifying strong and weak parts of the network

### BASIC MV/LV NETWORK ANALYSIS

- Voltage profile plots for single and multiple feeders
- Feeder analysis tools incl. feeder load scaling for simple & meshed feeders
- Automated schematic visualisation of feeder topology
- Radial feeder tools incl. voltage and phase technology change tools
- Backbone calculation determining the main connections between meshed feeders
- LV network analysis functions
- Stochastic load modelling

### POWER EQUIPMENT MODELS

- Large and comprehensive Equipment Type Library, fully version-controlled with regular model updates
- Various synchronous and asynchronous motor/generator models
- Asynchronous machine parameter identification
- Doubly-fed induction machines
- Static generator for modelling wind- and PV-generators, fuel cells, micro-turbines, etc.
- PV system with integrated power calculation based on solar radiation
- External grids, AC and DC voltage and current sources
- Simple and complex load model, special MV and LV load models, including input based on yearly energy values and load profiles
- Network branches (OHL, cable, branches, line couplings, tower geometries, cable systems, busbar trunking systems, 2-winding transformer and auto transformer, 3-winding transformer and auto transformer, 4-winding transformer and autotransformer, booster transformer, step-voltage regulator, reactor, series capacitor, common impedance, etc.)
- Overhead line and cable parameter calculation
- Controller objects such as station & secondary controller including various control methods, transformer tap controller, virtual power plants, capability curves
- Static var compensation (SVC), thyristor controlled series compensation (TCSC), shunt/filter models, and harmonic filters (single-tuned, double-tuned, high pass)
- Modelling of HVDC interconnections (rectifier/inverter, two-level VSC, half- and full-bridge MMC converter)
- Power electronic devices and discrete components (diode, thyristor, PVM converter, rectifier/inverter, DC valve, soft starter, etc.)
- DC/DC converter, inductive DC-coupling
- DC Battery, DC machine and **DC load models** **NEW**
- Explicit modelling of neutral wiring
- Protection devices with over 30 basic function blocks
- Protection device library (static/dynamic functions)
- Fourier, harmonic and impulse current sources, FFT, clock, S&H, etc.
- Composite models for branch and node models, incl. template library for handling composite models
- Parameter characteristics (scaling factor, vector, matrix, files) for modelling of load profiles, wind/PV infeed, temperature dependencies, etc.
- Time and Time-Profile Characteristics for simplified modelling of (recurrent) time series
- Grid organisation and element grouping (zones, areas, boundaries, circuits, routes, feeders, operators, owners, etc.)

## NETWORK REPRESENTATION

- Support of any kind of meshed/radial 1-, 2-, 3- and 4-wire AC and DC networks with combined AC and DC modelling for all available analysis functions
- Single-phase, two-phase, bi-phase and three-phase technology with/without neutral
- Hierarchical data model including sites, substations, bays, primary and secondary equipment
- Detailed primary and secondary substation models (single/double busbars w/o tie breaker, 1-1/2 busbar, bypass busbar), extendable for user-specific busbar configurations including protection schemes
- Switches and substation equipment such as CB, fuse, disconnecter, load break switch, grounding switch, NEC/NER, CT, VT, CVT, **combined CT/VT NEW**, etc.
- Running arrangements and switching rules for substation automation

## NETWORK MODEL MANAGEMENT

### Single- and Multi-User Edition

- User-friendly and powerful Data and Object Manager
- Network Model Manager with spreadsheets for convenient management of network equipment data and results
- Flexible grouping and filter functionality
- Grid Variations management with time-stamped grid Expansion Stages
- Highly flexible Study Case concept with definable Operation Scenarios, Variations, Grids and Triggers
- Project Overview window with extended functionality for simplified management of Study Case configuration
- Data (Model) Extension concept for user customisation with **user-defined classes NEW** and attributes
- Flexible parameter characteristics
- Master- and Derived Projects with Merge Tools
- Project combination and project connection assistant (horizontal/vertical)
- Project versioning
- Database Undo and Rollback function

### Team Edition

- Includes all Multi-User Edition features
- Multi-User database with team working functionality and support of simultaneous user sessions
- User accounting, data access and function access rights
- User authentication via PowerFactory user administration, **including password policy settings, or via external authentication services, such as LDAP or Microsoft Active Directory NEW**
- Database housekeeping mechanisms
- Project archiving
- Offline Mode via locally cached database and possibility for synchronisation with multi-user database when connected to the network (requires Network Licence with Floating Licence)

## NETWORK DIAGRAMS AND GRAPHIC FEATURES

- Simplified single line diagrams for schematic and design views
- Detailed single line diagrams showing full switch & component model including primary and secondary equipment
- Graphical representations of **sites NEW**, substations and **bays NEW**
- Intelligent Overview Diagrams supporting node & branch views
- Geographic Diagrams (GPS-based) with background maps
- Background Maps representation automated via mapping server interface (e.g. Open Street Map, Google Maps<sup>1</sup>, Esri ArcGIS<sup>1</sup>)
- Graphic search option for network elements in diagrams, including geographic search
- **Flexible diagram layer concept with opacity settings for customisable layer combinations NEW**, including annotation layers for enriched visualisation options (network diagram, maps, images, texts, plots, etc.)
- Single line diagram handling across Variations and Expansion Stages
- Automated drawing of Site and Substation Diagrams
- Diagram Layout Tool for auto-drawing or assisted drawing of full or partial network, feeders, protection devices (CTs, VT, relays), branches, site and substation diagrams as well as auto-expansion of diagram
- User-definable symbols and composite graphics
- Global template libraries (e.g. for substation configurations, WTGs, PV systems)
- Numerous diagram colouring and result visualisation modes
- Flexible Heatmap background colouring scheme
- Navigation Pane facility
- View Bookmarks for quick navigation between zoom areas
- Diagram export and printing functionality with print area definition and print previewing

## RESULTS AND REPORTING

- Extremely rich set of calculation quantities
- Comprehensive text and interactive spreadsheet reports
- Tabular result views via configurable Flexible Data pages
- Flexible reporting and result visualisation in network diagrams
- Interactive output window with flexible filter functionality
- Numerous interactive plots for result visualisation (differential and time-over current protection, harmonics, stability and transients, eigenvalue analysis, etc.)
- Easy-to-use plot navigation (e.g. scaling, zooming, moving/sliding, stretching/compressing, etc.)
- Intelligent Plots with statistics functionality
- Digital Signal plot and Fault Recorder view
- Powerful results comparison mode

<sup>1</sup> Upon request: additional license agreements with map service providers apply.

### Base Package

#### DATA CONVERTERS

- Support of various data conversion and interfacing options for bi-directional data exchange
- DGS interface: Bi-directional, flexible DlgSILENT data exchange format (ASCII, XML, CSV, ODBC) supporting GIS and SCADA interfacing
- Data import converter:
  - PSS/E, PSS/U (Siemens/PTI)
  - Sincal (Siemens)
  - UCTE (ENTSO-E)
  - CIM data exchange tools<sup>2</sup> (ENTSO-E Profiles 2009, CGMES 2.4.15 certified) including CIM model editor and validator
  - Neplan
  - Integral 7 (FGH)
  - Elektra
  - ISU (SAP)
  - Reticmaster (Inspired Interfaces)
  - PRAO<sup>2</sup>
- Data export converter:
  - CIM<sup>2</sup> (ENTSO-E Profiles: 2009, CGMES 2.4.15 certified)
  - UCTE<sup>2</sup> (ENTSO-E)
  - PSS/E<sup>2</sup> (Siemens/PTI)
  - Integral 7<sup>2</sup> (FGH)

#### GENERAL SOFTWARE INFORMATION

- Comprehensive examples including linked demo videos on the DlgSILENT YouTube channel
- Interactive introductory tutorial and various advanced functions tutorials
- Complete and well-structured User Manual (1200+ pages)
- Detailed Technical References for all Power Equipment models
- User-friendly GUI with new modern appearance, available in multiple languages
- Output window including icons, colours, tabs and filters for categorisation and visualisation
- Integrated script editor
- User profiles with customisable toolbars, dialogs and context menus
- Functional integration for all power system applications incl. T&D, industry, renewables, smart grids, etc.
- Various interfaces for communication and data exchange with third-party systems
- Fully compatible with MS Windows 32- and 64-bit versions
- **Compliance with GDPR (General Data Protection Regulation) NEW**

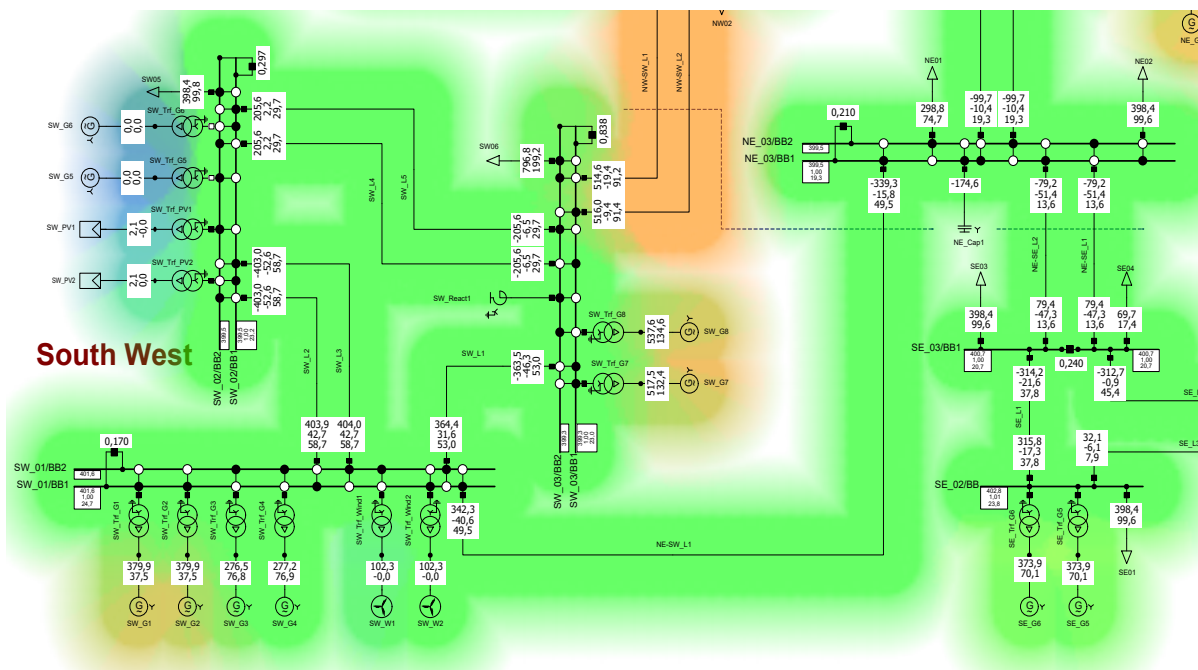

<sup>2</sup> Not part of the Base Package; this function has to be requested separately.



# Advanced Functions

## CONTINGENCY ANALYSIS

- AC, DC and AC linearised **NEW** analysis methods, including regional assessment
- Fast contingency screening with recalculation of critical cases using AC method
- Single and multiple time phase consideration
- Remedial Action Schemes for flexible and dynamic analysis of post-fault actions
- Substation automation via switching schemes
- Automatic time sweep contingency analysis of a 24 hour time period incl. parallelisation
- Generator effectiveness and quad booster effectiveness
- Enhanced Fault Case management
- Comprehensive spreadsheet reporting features incl. graphical visualisation of critical cases
- Tracing of individual contingency cases
- Contingency comparison mode
- Support of parallelised Contingency Analysis for multiprocessor hardware
- Reloading of results

## QUASI-DYNAMIC SIMULATION

- Medium- to long-term simulations based on steady-state analysis
- Time and Time-Profile characteristics for simplified modelling of (recurrent) time series
- Consideration of planned outages, network Variations & Expansion Stages
- Flexible definition of simulation time range with arbitrary resolutions
- Simulation plots and tabular reports including statistical analysis
- QDSL-language for user-definable models (load flow and quasi-dynamic equations)
- QDSL model encryption functionality<sup>3</sup> **NEW**
- Support of parallelised simulation on multiprocessor hardware
- Reloading of results

## NETWORK REDUCTION

- Flexible definition of boundaries with Boundary Definition Tool
- Calculation of (AC or DC **NEW**) load flow and short-circuit equivalent
- Support of load, Ward, extended Ward and REI-DIMO equivalents
- Numerous options for aggregation of non-linear elements
- Capturing of reduction via Variation for convenient toggling between original and equivalent grid

## PROTECTION FUNCTIONS

- Comprehensive relay library with relay models suitable for steady-state, RMS and EMT calculations
- Synchronisation with DigSILENT StationWare
- Highly-detailed spreadsheet reports for protection settings (overcurrent, distance, voltage, frequency protection)
- Graphical visualisation and editing of fuses, relays, CTs and VTs including auto layout functionality
- Protection Audit
  - Validation tool for protection settings and configurations
  - User-configurable fault types assessments
  - Automatic determination of protection topology
  - Automatic short-circuit calculation
  - Multiple predefined reports with auto-identification of critical protection settings (device coordination, device tripping times, fault clearing times)
  - Short-Circuit Trace functionality for steady-state simulation of fault clearance and relay responses

## Time-Overcurrent Protection

- Overcurrent-time diagram with drag & drop functionality including auto-generated graphical legend
- Cable and transformer damage curves
- Motor starting curves
- Automatic display of measured currents
- Steady-state response checks
- Steady-state short-circuit simulation with tracing of individual steps
- Steady-state tripping times for transient or sub-transient current/voltage values
- Transient response checks (requires Stability Analysis functions (RMS) or Electromagnetic Transients functions (EMT))
- Protection Graphic Assistant
  - Customisable short-circuit sweep diagrams including visualisation of protection settings
- Protection Model Features
  - Fuses and low-voltage circuit breakers
  - Positive-, negative-, zero-sequence inverse and definite time characteristics
  - Thermal overload characteristics
  - Directional elements supporting cross-, self- and memory polarising, Wattmetric method
  - Differential unit with harmonic blocking for multiple harmonic orders
  - Generic and detailed manufacturer-specific recloser units
  - Signal transmission between relays, inter-tripping, interlocking schemes
  - Detailed CT, VT, combined CT/VT **NEW**, and CVT models including saturation
  - Over-, under-voltage inverse and definite time characteristics
  - Programmable logic unit
  - Over-, under-frequency and df/dt inverse and definite time characteristics<sup>4</sup>

<sup>3</sup> Requires DPL/DSL/QDSL Crypting Function licence

<sup>4</sup> Requires Stability Analysis Functions (RMS) licence

## Advanced Functions

### DISTANCE PROTECTION

- Includes full "Time-Overcurrent Protection" module
- P-Q diagrams **NEW** and R-X diagrams with support of the display of measured impedance trace
- Time-distance diagrams, with metric or calculated display of zone reach in forward and reverse direction
- Protection Graphic Assistant
  - Reach of protection zones colourings in diagrams
- Protection Coordination Assistant
  - Automatic calculation of protection settings
  - Support of various coordination methods and setting rules
- Protection model features
  - Generic and detailed manufacturer-specific Mho, polygonal distance zones and distance starting units
  - Out of step detection and power swing blocking unit<sup>5</sup>

### ARC-FLASH ANALYSIS

- Arc-Flash calculation in accordance with IEEE-1584 2002, NFPA 70E-2012 and BGI/GUV-I 5188
- Incident Energy, Flash-Protection Boundary and PPE Category on the single line diagram
- Automated preparation of Arc-Flash labels via MS Excel/Word
- Automatic protection-based fault clearing time determination<sup>6</sup>
- Calculation of arcing-current energy

### CABLE ANALYSIS

#### Cable Sizing

- Automatic cable sizing based on IEC 60364-5-52, NF C15-100, NF C13-200, BS 7671, and VDE 0100-520 etc.
- Cable reinforcement optimisation
- Verification of global and/or individual thermal & short-circuit constraints
- Verification of user-defined voltage drops per terminal and/or feeders
- Balanced (positive sequence) or unbalanced calculation with support of all phase technologies (1-, 2- and 3-phase systems, w/o neutral conductor)
- System phase technology and cable type consistency checks in the feeder
- Various verification reports and automatic modification of cable types in the existing network via network Variations

#### Cable Ampacity Calculation

- Cable Ampacity calculation based on IEC 60287 or Neher-McGrath method
- Evaluation of maximum allowable current for cables based on cable material, laying arrangement and environmental data including presence of external heat sources
- Convenient cable layout modelling capabilities, supporting all laying arrangements of single and multi-core cables
- Rich reports and automatic modification of cable derating factors in the existing network via network Variations

### POWER QUALITY AND HARMONIC ANALYSIS

#### Harmonic Load Flow

- Harmonic voltage and current indices (IEC 61000-3-6, BDEW 2008)
- Balanced (positive sequence) and unbalanced (multiphase) model
- Unbalanced harmonic sources
- Non-characteristic and inter-harmonics
- Multiple harmonic injections: current and voltage sources, thyristor rectifiers, PWM-converters, SVS, non-linear loads, Norton equivalents
- Background distortion frequency-dependent R and L values
- Various harmonic distortion indices such as THD, HD, HF, THF, TAD, TIFmx, total RMS currents and voltages, loadings and losses (defined according to IEEE and DIN/IEC standards)
- Harmonic distortion plot with pre-defined distortion limits according to international standards
- Waveform plots
- Calculation of K-Factors and Loss Factors for 2-winding transformers (UL1562, EN 50464-3 (replaces BS 7821), EN 50541-2, IEEE C.57.110-1998)

#### Flicker Analysis

- Flicker Assessment (IEC 61400-21)
  - Short- and long-term flicker disturbance factors for continuous and switching operations
  - Relative voltage changes
- Flickermeter (IEC 61000-4-15)
  - EMT or RMS signals
  - Support of multiple file formats such as COMTRADE, CSV, user-defined, etc.

#### Frequency Sweep

- Automatic step size adaption or constant step size
- Balanced (positive sequence) and unbalanced network model
- Self and mutual impedances/admittances (phase and sequence components)
- Frequency-dependent R and L values and line/ cable models
- Spectral density of voltage amplitude/angle

#### Filter Analysis

- Various filter models
- Design and layout parameters
- Filter sizing and verification reports
- Ripple control analysis

<sup>5</sup> Requires Stability Analysis Functions (RMS) or Electromagnetic Transients (EMT) licence

<sup>6</sup> Requires Protection Functions licence

## CONNECTION REQUEST ASSESSMENT

- According to D-A-CH-CZ guidelines
- According to BDEW 2008 and VDE-AR-N 4105 guidelines
- Assessment of:
  - Voltage changes and flicker
  - Voltage unbalance
  - Loadings and short-circuit currents
  - Harmonics, interharmonics, audio-frequency ripple control
  - Commutation notches
  - Interharmonic voltages
  - HV resonances

## TRANSMISSION NETWORK TOOLS

### PV curves calculation

- Voltage stability assessment by determination of critical point of voltage instability
- Support contingency analysis, i.e. detection of “limiting contingency”

### QV curves calculation

- Voltage stability limit assessment by evaluating the bus voltage change w.r.t. variation of injected reactive power
- Evaluating of stable operating points for various system loading scenarios, including contingencies
- Determination of reactive power compensation by superposition of capacitor characteristics in QV plots

### Power Transfer Distribution Factors

- Analysis of the impact of a power exchange between two regions
- Various load and generation scaling options

### Transfer Capacity Analysis

- Determination of maximum power transfer capacity between two regions
- Various load and generation scaling options for exporting and importing region
- Thermal, voltage and contingency constraints options

### Outage Planning<sup>7</sup>

## DISTRIBUTION NETWORK TOOLS

### Tie Open Point Optimisation

- Optimisation of tie open point positions subject to loss minimisation, improvement of system reliability, or **minimisation of switching actions** **NEW**
- Support of balanced/unbalanced systems
- Branch and **boundary flow limits** **NEW**, absolute voltage, and voltage drop/rise constraints
- Enhanced reporting features and graphical visualisation, including automatic identification of tie open points
- Various methodologies, such as mesh exploration heuristic, genetic algorithms, and simulated annealing

### Voltage Profile Optimisation

- Verification and optimisation mode
- Voltage profile optimisation for bi-directional power flows in systems with a high level of distributed generation
- Determination of optimal distribution transformer tap positions for production and consumption cases (simultaneous or independent)
- Combined consideration of MV and LV feeder voltage profiles with enhanced plotting features

### Phase Balance Optimisation

- Automatic reconnection of loads, generators, and/or branch elements in order to achieve minimal power unbalance
- Minimisation of unbalance at feeding point or average unbalance in feeder
- High flexibility to also allow for partial reconfiguration
- Capturing of results via Variations for convenient toggling of original and optimised phase connections
- Various methodologies, such as standard heuristics, genetic algorithms, and simulated annealing

### Optimal Capacitor Placement

- Determination of optimal locations, types, phase technology and sizes of capacitors
- Economic assessment considering costs of losses against installation costs under predefined voltage constraints
- Support of load variation via characteristics

### Hosting Capacity Analysis **NEW**

- Evaluation of the maximum distributed energy resources (DER) and/or spare load capacity of a network
- Consideration of thermal, voltage, protection<sup>8</sup> and power quality limits<sup>9</sup>
- Graphical visualisation of maximum, minimum and average capacity of the system
- Tabular reports of the maximum capacities and limiting components for feeders and terminals

### Outage Planning<sup>4</sup>

## OUTAGE PLANNING

- Tool for management of planned outages
- Schedule supports various recurrence patterns
- Support of associated remedial actions
- Action macro recorder to facilitate definition of remedial action events
- Integrated functions to apply and reset planned outages
- Tabular reports and Gantt diagrams with various filter options
- Graphical visualisation of outage and remedial actions, including affected regions

<sup>7</sup> The Outage Planning module is part of the Transmission and Distribution Network Tools

<sup>8</sup> Requires Protection Function licence

<sup>9</sup> Requires Power Quality and Harmonics Analysis licence

## Advanced Functions

### PROBABILISTIC ANALYSIS

- Network assessment based on probabilistic input data
- Supports Probabilistic Load Flow and Probabilistic Assessment of OPF<sup>10</sup>
- Unlimited stochastic input data modelling with flexible distribution curve objects
- Includes probabilistic modelling of generation with PV systems and/or wind generators, as well as variable load consumption
- Support of numerous distributions, such as uniform, normal, log-normal, Weibull, exponential, geometric, Bernoulli, finite discrete
- Modelling of dependencies via correlation objects
- Auto-conversion tool to estimate distributions and correlations based on historic profiles/ time series data
- Monte Carlo and fast Quasi-Monte Carlo method
- Determination of statistical results for any calculation quantity, including means and standard deviations (with their confidence intervals), maxima, minima, higher order momenta
- Rich post-processing and plotting facilities for calculation results, including their distribution functions, density functions, correlations
- Post-assessment of critical worst-case or average cases via Probabilistic Analyser

### RELIABILITY ANALYSIS FUNCTIONS

#### Failure Models

- Line, transformer, distribution transformer, and busbar failures
- Generator failures with stochastic multi-state model
- n-1, n-2 and common mode failures (n-k)
- Double earth faults
- Independent second failures
- Protection/circuit breaker failures
- Protection over-function

#### Optimal Power Restoration

- Failure effect analysis (FEA)
  - Automatic protection-based fault clearing
  - Intelligent high-end system restoration with potential network reconfiguration and load-shedding
  - Support of branch and **boundary flow limits** **NEW**, absolute voltage, and voltage drop/rise constraints
  - Sectionalising (remote controlled switches, short-circuit indicators, manual restoration)
  - Substation automation with switching rules
- Animated tracing of individual cases
- Detailed reports for restoration action plans

#### Reliability Assessment

- Fast state enumeration incl. optimal power restoration techniques for balanced/unbalanced systems
- Calculation of all common reliability indices (IEEE 1366)
- Contribution of components to reliability indices
- Support of load variation, incl. load distribution curves
- Consideration of maintenance schedules

- Support of various tariff and cost models
- Support of parallelised Reliability Assessment for multiprocessor hardware

#### Optimal Remote Control Switch (RCS) Placement

- Determination of optimal number and locations for RCS installation for improvement of system reliability
- Economic assessment for various objective functions

#### Optimal Manual Restoration

- Calculation of optimal switching scheme for manual power restoration phase

#### Generation Adequacy Analysis

- Stochastic assessment of system supply capabilities (loss of load probabilities, capacity credit, etc.)
- Consideration of generator outages and maintenance schedules (Monte Carlo), as well as load variation
- Enhanced probabilistic models for wind generation
- Rich suite of reporting and plotting tools

### OPTIMAL POWER FLOW (OPF)

#### Reactive Power Optimisation (OPF I)

- Minimisation of total or partial grid losses
- Maximisation of reactive power reserve
- Reactive power optimisation (interior point method)
- Various controls such as:
  - Generator reactive power
  - Transformer and shunt taps
  - Static Var Systems
- Flexible constraints such as:
  - Branch flow and voltage limits
  - Generator reactive power limits
  - Reactive power reserve
  - Boundary flows

#### Economic Dispatch (OPF II)

- Various objective functions, e.g.:
  - Minimisation of losses
  - Minimisation of costs (eco dispatch)
  - Minimisation of load shedding
  - Optimisation of remedial post-fault actions, e.g. booster tap changes (pre- to post-fault)
- AC optimisation (interior point method)
- DC optimisation (linear programming)
- Various controls such as:
  - Generator active and reactive power
  - Transformer, quad booster and shunt taps
  - Static Var Systems

<sup>10</sup> Probabilistic assessment of OPF also requires Optimal Power Flow licence.



- Flexible constraints such as:
  - Branch flow and voltage limits
  - Generator active and reactive power limits
  - Active and reactive power reserve
  - Boundary flows
- Contingency constraints (DC only)

### UNIT COMMITMENT AND DISPATCH OPTIMISATION NEW

- Power plant dispatch optimisation for Market Simulation
- Minimisation of redispatch costs, such as operating, emission & startup costs, including curtailment of renewables / load shedding
- Optimisation (AC and/or DC) of generator dispatch schemes, as well as control units such as phase shifters and HVDCs
- State-of-the-art solutions for performance and memory efficiency
- User-definable time periods and resolutions
- Constraints including branch & boundary flow limits, voltages, as well as ramping, minimum up/down times or spinning reserves of generators
- Support of Contingency Constraint optimisation
- Seamless integration of all market parameters into network model
- Numerous reporting facilities, and result visualisations
- For standard size optimisation problems: ships with built-in solver
- For solving large-scale problems: integrated optional interface<sup>11</sup> to external solvers such as CPLEX, GUROBI or data exchange via AMPL-NL file format

### TECHNO-ECONOMICAL ANALYSIS

- Economic assessment of network expansion strategies
- Net Present Value method considering costs of losses, investment costs, economic impact of failure rates (only with Reliability Analysis functions), and project schedules
- Efficiency ratio evaluation to determine optimal year of investment
- Support of parallelised execution of cases

### STATE ESTIMATION

- P, Q, I and V measurement models
- Measurement plausibility checks
- Automatic bad data detection/elimination
- Verification of system observability
- Various options to handle unobservable regions (e.g. pseudo measurements)
- Consideration of load flow constraints

### STABILITY ANALYSIS FUNCTIONS (RMS)

- Multi-phase AC networks, DC networks
- Support of balanced and unbalanced grid conditions
- Fast, fixed step size and adaptive step size algorithm

- A-stable numerical integration algorithms supporting long-term stability simulations with integration step sizes ranging from milliseconds to minutes, individually selectable for each model
- High precision event and interrupt handling
- Simulation of any kind of fault or event
- Transient motor starting (synchr./asynchr. machines)
- Support of all protection library relays
- Real-time simulation mode
- Simulation scan feature, e.g. frequency scan, loss of synchronism scan, synchronous machine speed scan, voltage-/voltage recovery scan, fault ride through scan or common variable scan
- Frequency Analysis Tool, including Fast Fourier Transform (FFT) and Prony Analysis for single point in time as well as time-range assessment
- Frequency Response Analysis tool for dynamic models with Bode/Nyquist plots

### DigSILENT Simulation Language (DSL) for Dynamic RMS Modelling

- Graphical editor for drawing any kind of block diagram (AVR, prime mover, relay, etc.)
- Fully flexible signal wiring schemes having access to any grid object and their parameters via definition of Frames
- Nesting of frames and model building blocks
- Fully flexible definition of simulation functions via the DSL syntax
- High precision built-in macros & functions
- Automatic initialisation of complex, non-linear models
- Large built-in standard model library, including IEEE and CIM ENTSO-E models
- Generic C interface for user-defined controller models
- IEC61400-27-1 interface for external models
- Automatic DSL-to-C interface converter
- Support of model pre-compilation for improved performance
- Support of MATLAB/Simulink interface
- OPC interface<sup>12</sup> for real-time applications
- IEEE C37.118 simulation interface for PMU data streaming
- DSL Encryption function<sup>13</sup>

### Co-Simulation Functionality NEW

- Single domain co-simulation (RMS balanced – RMS balanced, RMS unbalanced – RMS unbalanced)
- Multiple domain co-simulation (RMS balanced – RMS unbalanced – EMT<sup>13</sup>)
- Co-simulation with external solver<sup>14</sup> (e.g. third party power systems simulation program) via IEEE C37.118 communication interface
- Computing supported as built-in for increased performance
- Both accurate (implicit) and fast (explicit) co-simulation methods available
- Easy to define co-simulation border using boundary objects
- Any number of co-simulation regions can be defined
- Co-simulation of networks split by regions depending on any criteria: localisation, voltage levels, etc.

<sup>11</sup> Requires Unit Commitment and Dispatch Optimisation Interface licence. CPLEX and GUROBI licence to be purchased separately

<sup>12</sup> This function has to be requested separately.

<sup>13</sup> Requires Electromagnetic Transients (EMT) licence

<sup>14</sup> Requires separate „Co-Simulation Interface“ licence

### Advanced Functions

#### ELECTROMAGNETIC TRANSIENTS (EMT)

- Integrated simulation of electromagnetic transients in multiphase AC and DC systems
- Fast, fixed step size or adaptive step size algorithm
- Simulation of static var compensations (SVC), thyristor controlled series compensations (TCSC), FACTS, STATCOM, etc.
- Modelling of HVDC interconnections (rectifier/inverter, two-level VSC, half- and full-bridge MMC converter)
- Power electronic devices and discrete components (diode, thyristor, PWM converter, rectifier/inverter, DC valve, soft starter, etc.)
- Constant and frequency-dependent distributed parameter OHL models, universal frequency dependent cable model
  - OHL/cable constants calculation
  - OHL transpositions
  - Single/multi-core and pipe-type cables
  - Cable cross-bonding
  - Semi-conducting layers
- Non-linear elements and saturation characteristics, **including definition of hysteresis NEW**
- Series capacitors incl. spark gap model
- Surge arrester models
- Impulse voltage & current source for lightning surge analysis
- Support of AC-DC intercircuit fault events
- Accurate EMT models of renewable generation (wind/PV, etc.) and storage systems
- Discrete R-L-C elements
- Flexible template definition to create and re-utilise user-specific models library
- Insulation coordination analysis including temporary (TOV), switching (SOV) and lightning (LOV) transient over-voltages
- Stochastic switching analysis and point-on-wave (POW) switching
- Frequency Analysis Tool, including Fast Fourier Transform (FFT) and Prony Analysis for single point in time as well as time-range assessment
- Inrush, ferro-resonance, SSR and TRV studies
- COMTRADE file support
- Various options of triggering breaker closer events
- **Combined RMS and EMT simulation mode<sup>15</sup> NEW**

#### DlgSILENT Simulation Language (DSL) for EMT Modelling

- Contains the DlgSILENT Simulation Language for dynamic modelling (see RMS module for details)

#### Co-Simulation Functionality NEW

- Contains Co-Simulation functionality (see RMS module for details)
- Single and multiple domain co-simulation (RMS balanced, RMS unbalanced – EMT<sup>15</sup>)

#### MOTOR STARTING FUNCTIONS

- Single or multiple motor starting
- Transient motor starting (synchr./asynchr. motors), with full support of controller models
- Steady-state motor starting

- Various motor starting methods (reactor, auto transformer, variable rotor resistance, star delta, etc.)
- Thermal limit check of cables and transformers
- Automatic starting check function, visualised in single line diagram
- Detailed report

#### SMALL SIGNAL STABILITY (EIGENVALUE ANALYSIS)

- Full and selective eigenvalue analysis
- Balanced (positive sequence) network representation, including combined AC and DC modelling, with non-conventional generation such as wind turbines, PV systems, HVDC, VSC and other FACTS devices
- Interactive eigenvalue, mode bar and mode phasor plots
- Visualisation of eigenvectors in network diagrams
- Tabular reports of eigenvalues incl. damped frequencies, damping time constants, etc.
- Detailed reports of oscillatory modes including participation factors of state variables, controllability and observability

#### SYSTEM PARAMETER IDENTIFICATION

- Parameter estimation of non-linear dynamic MIMO-systems fully integrated with DSL modelling

#### INTERFACES

- API - Application Interface (API is part of the module "Scripting and Automation", see following section)
- OPC DA/UA Interface - SCADA interoperability standard, A/D signal interfacing
- **Unit Commitment Interface (for external solvers CPLEX, GUROBI or data exchange via AMPL-NL file format) NEW**
- IEEE C37.118 simulation interface – PMU protocol
- **Co-Simulation interface: C37 protocol based third party EMT/RMS co-simulation interface NEW**

#### SCRIPTING AND AUTOMATION

- Python: Integration of Python as programming language with full PowerFactory data model access and rich function suite
- DPL (DlgSILENT Programming Language):
  - C-like syntax supporting unlimited access to PowerFactory objects, parameters and their functionality
  - Extendable function scope of DPL via C-Interface, thus allowing access to external data and applications
  - Encryption of DPL Scripts<sup>16</sup>
- Detailed Scripting Reference documentation for DPL/Python (700+ pages) including function descriptions and example code snippets
- Add-on Modules: framework for user-extendable function scope including data model extension concept for user-definable input attributes and result parameters
- API (Application Interface): C++ interface for full external automation of PowerFactory
- Task Automation Tool for parallelised execution of calculation functions and scripts

<sup>15</sup> Requires Stability Analysis functions (RMS) licence

<sup>16</sup> Requires DPL/DSL/QDSL Crypting Function licence

## SUPPORT SERVICES

- Continuous product maintenance and development
- Free version upgrades as well as regular software updates
- Professional support via customer portal or hotline
- Detailed manual and tutorial with comprehensive examples
- Knowledge Base including FAQs, application examples and demonstration videos
- Regular distribution of newsletter including information about PowerFactory releases and seminar schedules

## TRAINING AND SEMINARS

- Modular training concept covering all PowerFactory functions
- Standard and user-specific training courses
- Power system analysis seminars
  - Power system stability
  - Load flow and short-circuit
  - Harmonics
  - Electromagnetic compatibility
  - Grid connection of renewable generation
  - Protection
- Training courses and seminars are offered at DlgSILENT offices as well as at user's site

Availability of support services depends on existing licence agreement.  
For more details, see our PowerFactory Maintenance and Support Services Flyer that is available on the Download Area on our website.



## SALES CONTACT

**DlgSILENT GmbH**  
Heinrich-Hertz-Straße 9  
72810 Gomaringen  
Germany

## PHONE

+49 7072 9168-0  
+49 7072 9168-88 (Fax)

## MAIL

mail@digsilent.de  
www.digsilent.de

# DIGSILENT | Company Profile

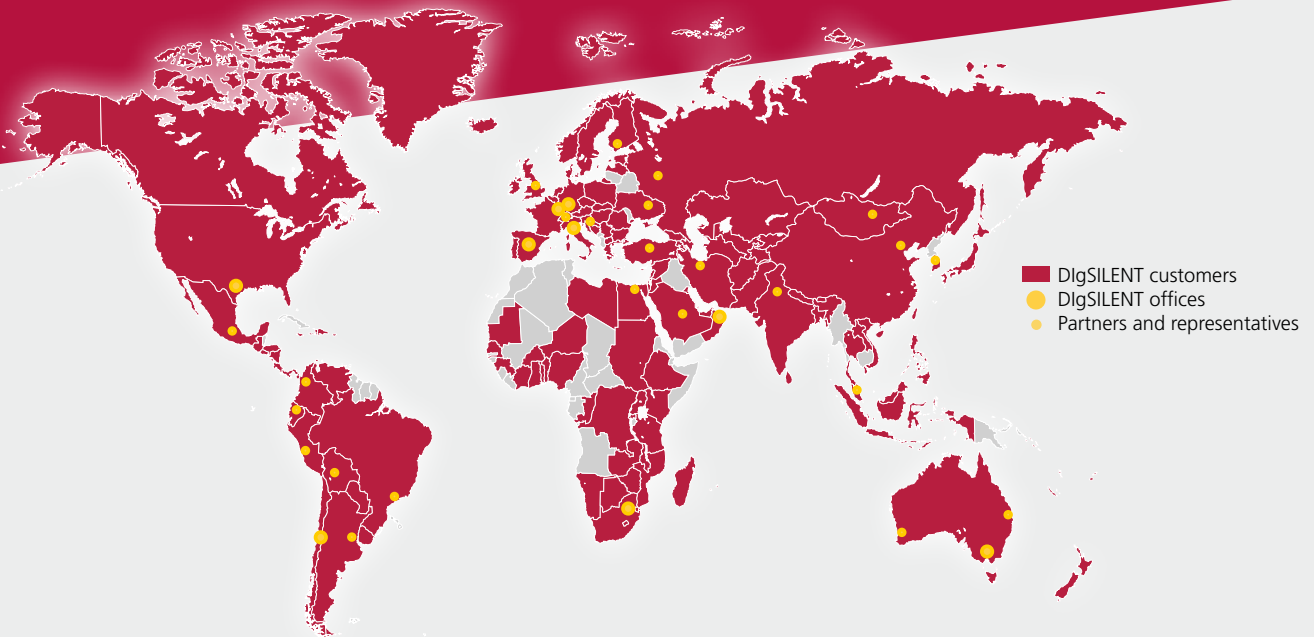

**DIGSILENT** is a consulting and software company providing engineering services in the field of electrical power systems for transmission, distribution, generation and industrial plants.

**DIGSILENT** was founded in 1985 and is a fully independent and privately owned company located in Gomaringen/Tübingen, Germany. Digsilent continued expansion by establishing offices in Australia, South Africa, Italy, Chile, Spain, France, the USA and Oman, thereby facilitating improved service following the world-wide increase in usage of its software products and services. Digsilent has established a strong partner network in many countries such as Mexico, Malaysia, UK, Switzerland, Colombia, Brazil, Peru, China and India. Digsilent services and software installations have been used in more than 150 countries.

## DIGSILENT PowerFactory

Digsilent develops the leading integrated power system analysis software PowerFactory, which covers the full range of functionality from standard features to highly sophisticated

and advanced applications including wind power, distributed generation, real-time simulation and performance monitoring for system testing and supervision. For various applications, PowerFactory has become the power industry's de-facto standard tool, due to PowerFactory models and algorithms providing unrivalled accuracy and performance.

**DIGSILENT StationWare** is a reliable central protection settings database and asset management system, based on .NET technology. StationWare stores and records all settings in a central database, allows modelling of relevant workflow sequences, provides quick access to relay manuals, interfaces with manufacturer-specific relay settings and integrates with PowerFactory, allowing powerful and easy-to-use settings coordination studies.

## DIGSILENT Monitoring Systems

Our Power System Monitoring PFM300 product line features grid and plant supervision, fault recording, power quality and grid characteristics analysis. The Grid Code Compliance Monitoring PFM300-GCC

product has been designed for continuous compliance auditing of power plants with respect to grid code requirements, thereby providing plant operators and utilities utmost transparency and non-compliance detection.

## DIGSILENT Consulting

Digsilent GmbH is staffed with experts of various disciplines relevant for performing consulting services, research activities, user training, educational programs and software development. Highly specialised expertise is available in many fields of electrical engineering applicable to liberalised power markets and to the latest developments in power generation technologies such as wind power and distributed generation. Digsilent has provided expert consulting services to several prominent PV and wind grid integration studies



Digsilent GmbH  
Heinrich-Hertz-Straße 9  
72810 Gomaringen  
Germany

P +49 7072 9168-0  
F +49 7072 9168-88  
mail@digsilent.de  
www.digsilent.de



Digsilent GmbH is certified to the ISO 9001:2015 standard. More information is available at [www.tuv-sud.com/ms-cert](http://www.tuv-sud.com/ms-cert).